

### FLASHING DETAIL

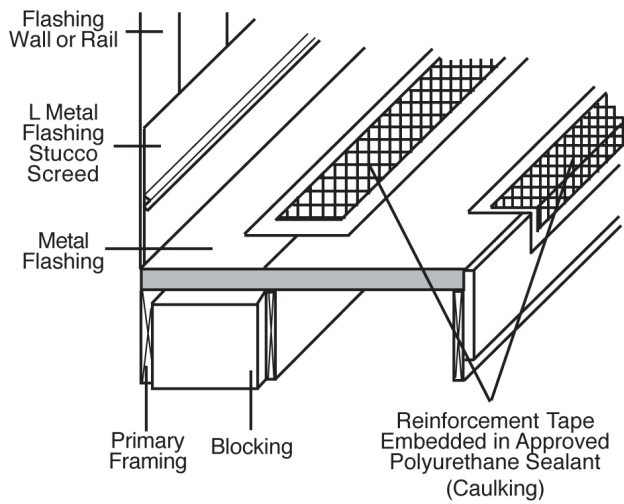

### CRACK DETAIL

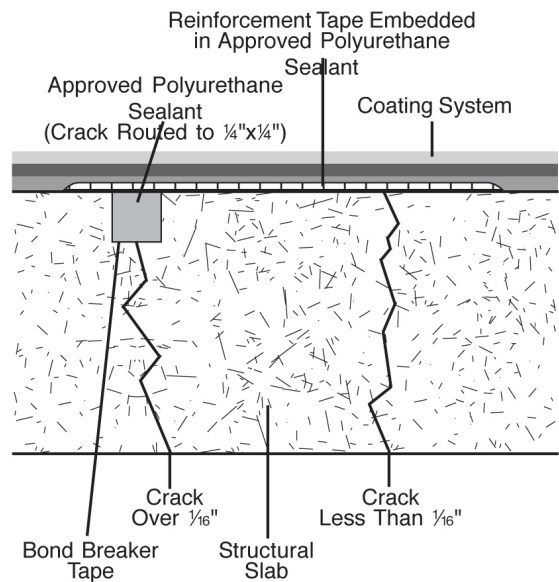

### CRACK CONTROL

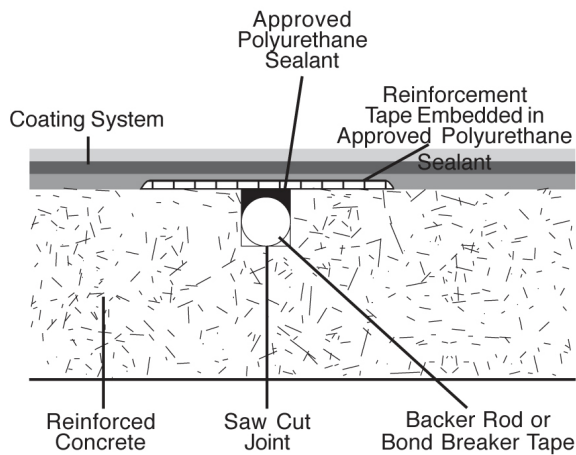

### TERMINATION DETAIL

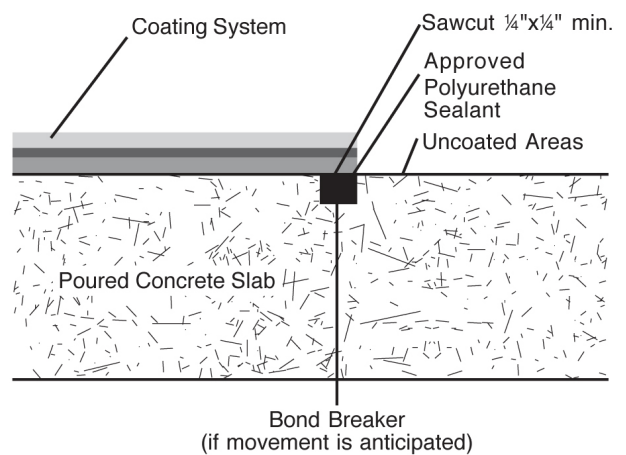

## JOINT AT WALL/SLAB

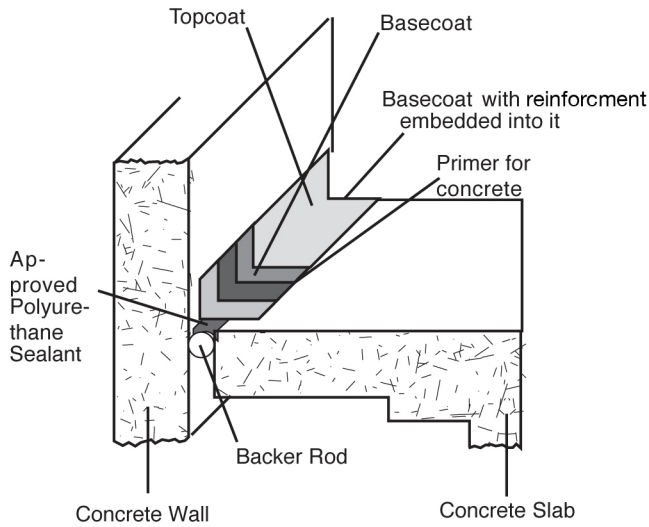

## WALL BEARING ON SLAB

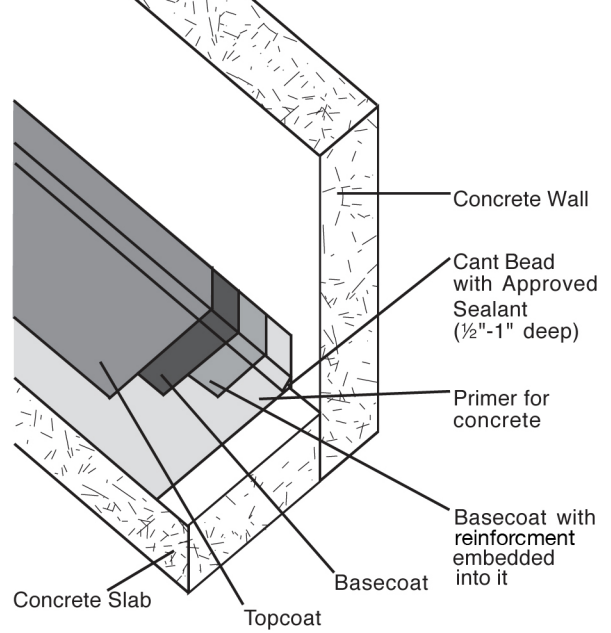

## DRAIN DETAIL

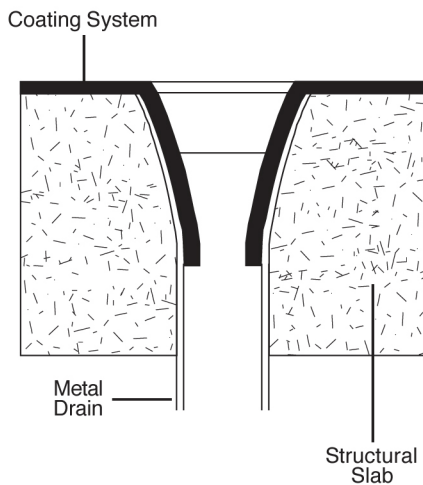

## BETWEEN SLAB

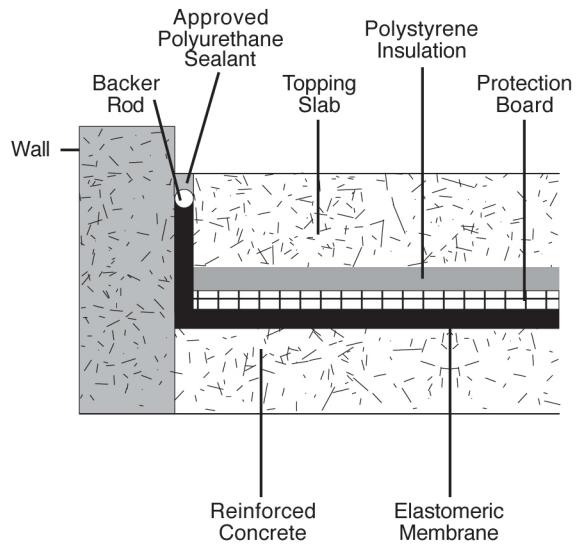

## VERTICAL PROJECTION

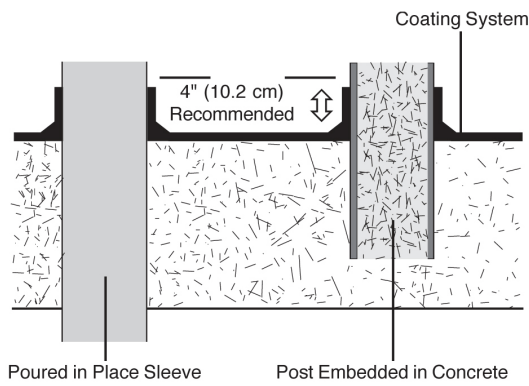

## VERTICAL PROJECTION BETWEEN SLAB

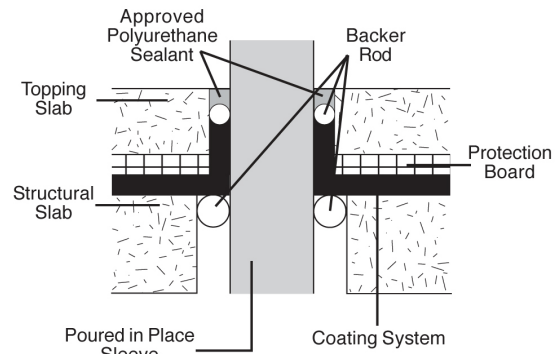

## EXPANSION JOINT DETAIL (Greater Than 1")

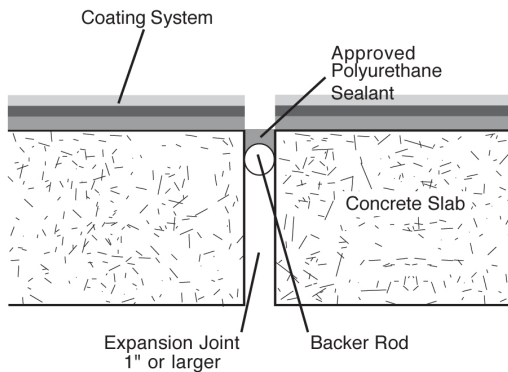

## EXPANSION JOINT DETAIL (Less than 1")

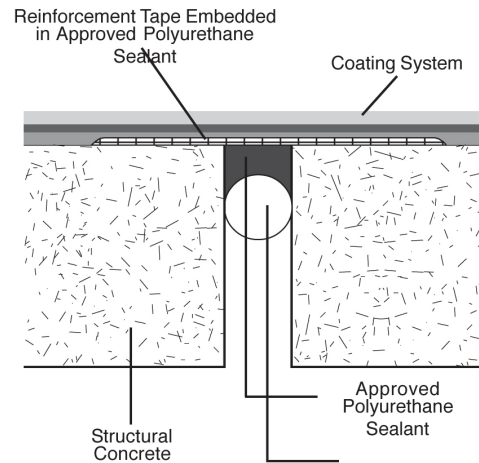

## WALL / FOOTING

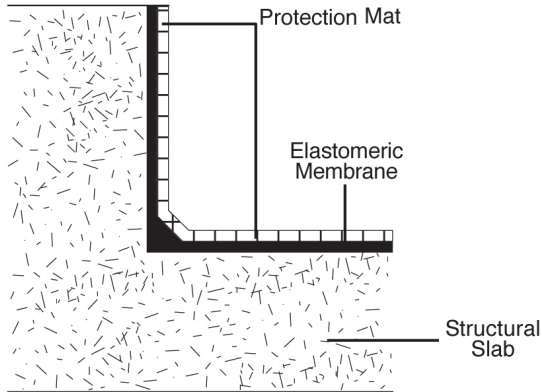

## REFLECTING POOLS

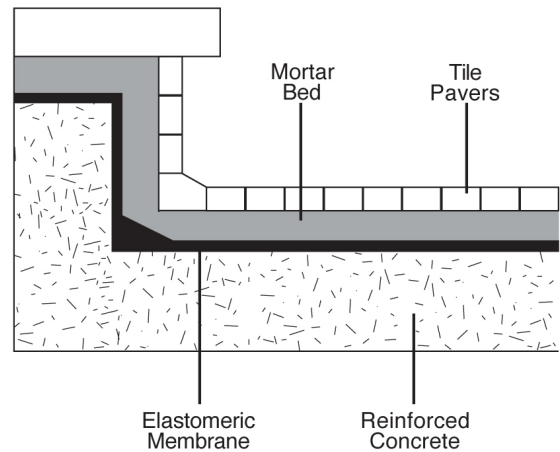

## PLANTER BOX

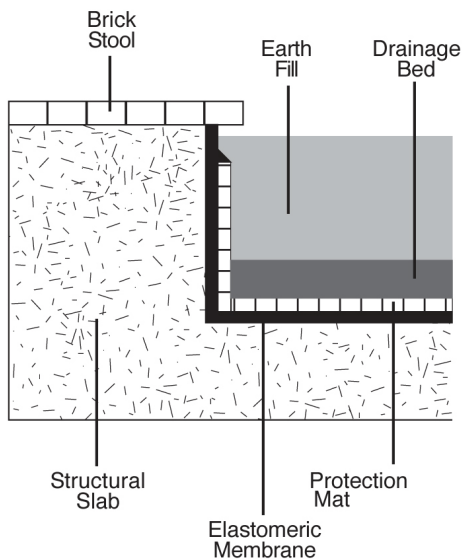

## THIN SET TILE

